

SynQor®

MQBL-28-2R5S

Single Output

HIGH RELIABILITY DC-DC CONVERTER

16-40V Continuous Input	16-50V Transient Input	2.5V Output	8A Output	83% @ 4A / 81% @ 8A Efficiency
-----------------------------------	----------------------------------	-----------------------	---------------------	--

FULL POWER OPERATION: -55°C TO +125°C

The MilQor® series of high-reliability DC-DC converters brings SynQor's field proven high-efficiency synchronous rectifier technology to the Military/Aerospace industry. SynQor's innovative QorSeal® packaging approach ensures survivability in the most hostile environments. Compatible with the industry standard format, these converters operate at a fixed frequency, have no opto-isolators, and follow conservative component derating guidelines. They are designed and manufactured to comply with a wide range of military standards.

MilQor®

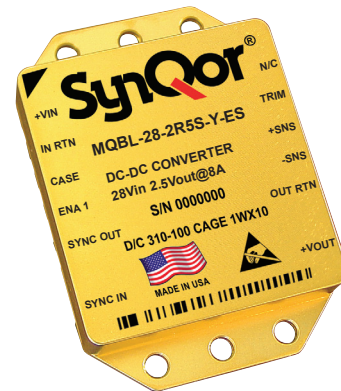

DESIGNED & MANUFACTURED IN THE USA
FEATURING QORSEAL® HI-REL ASSEMBLY

Design Process

MQBL series converters are:

- Designed for reliability per NAVSO-P3641-A guidelines
- Designed with components derated per:
 - MIL-HDBK-1547A
 - NAVSO P-3641A

Qualification Process

MQBL series converters are qualified to:

- MIL-STD-810F
 - consistent with RTCA/DO-160E
- SynQor's First Article Qualification
 - consistent with MIL-STD-883F
- SynQor's Long-Term Storage Survivability Qualification
- SynQor's on-going life test

In-Line Manufacturing Process

- AS9100 and ISO 9001 certified facility
- Full component traceability
- Temperature cycling
- Constant acceleration
- 24, 96, 160 hour burn-in
- Three level temperature screening

Features

- Fixed switching frequency
- No opto-isolators
- Output over-voltage shutdown
- Remote sense
- Clock synchronization
- Primary referenced enable
- Continuous short circuit and overload protection
- Input under-voltage and over-voltage shutdown

Specification Compliance

MQBL series converters (with MQHE filter) are designed to meet:

- MIL-HDBK-704-8 (A through F)
- RTCA/DO-160 Section 16, 17, 18
- MIL-STD-1275 (B, D) for $V_{IN} > 16V$
- DEF-STAN 61-5 (part 6)/(5, 6) for $V_{IN} > 16V$
- MIL-STD-461 (C, D, E, F)
- RTCA/DO-160(E, F, G) Section 22



MQBL-28-2R5S

Output: 2.5V

Current: 8A

Technical Specification

BLOCK DIAGRAM

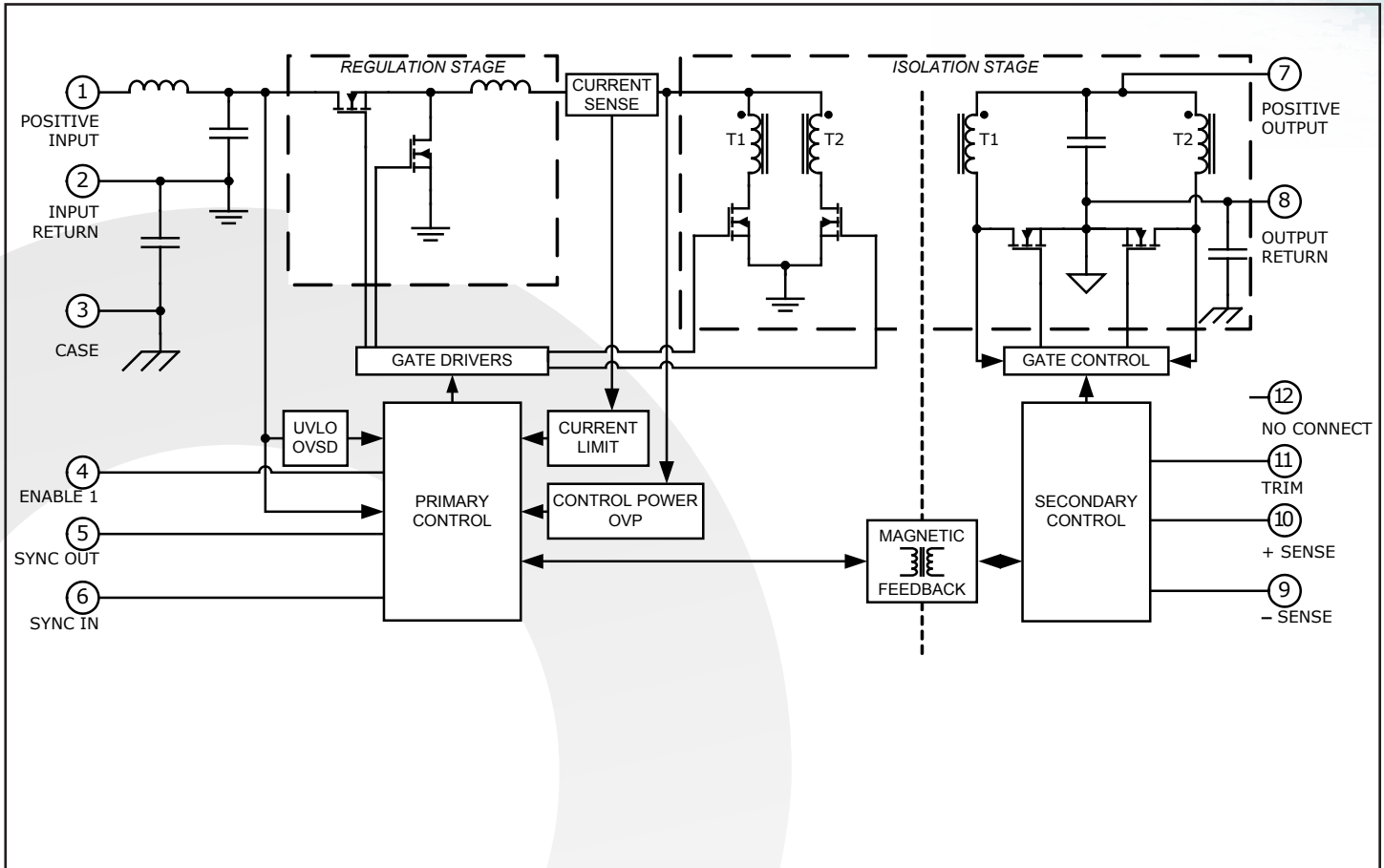

TYPICAL CONNECTION DIAGRAM

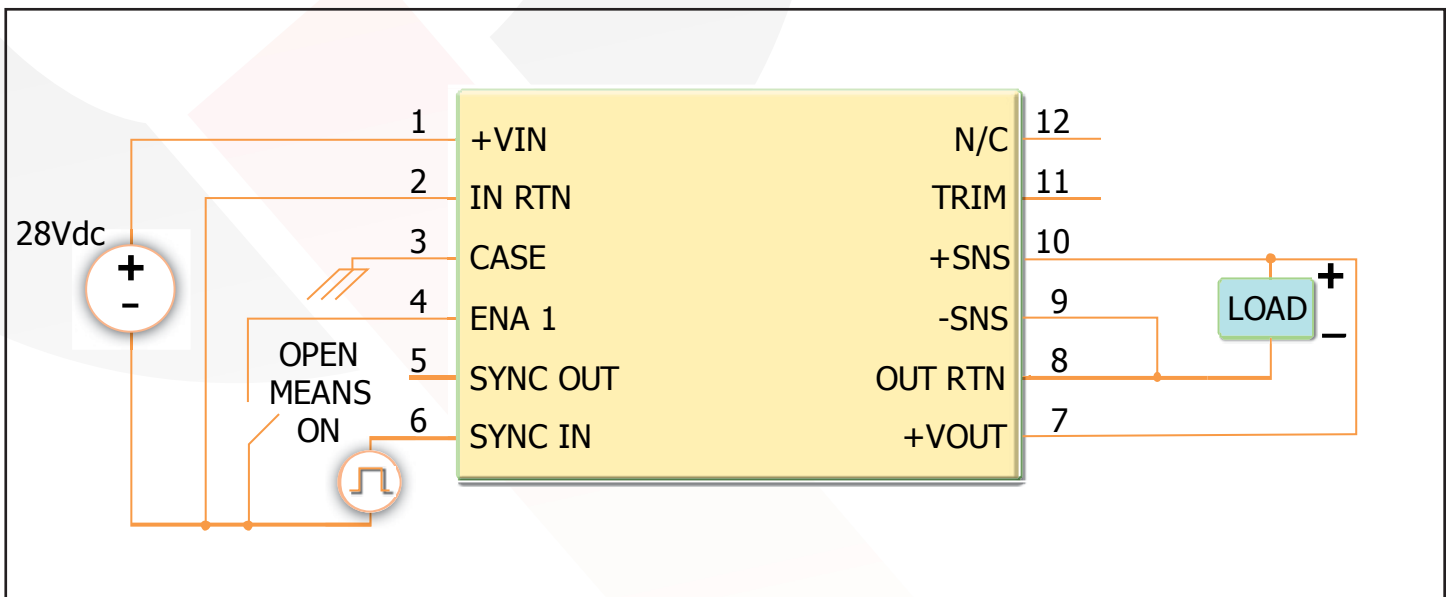

Technical Specification

MQBL-28-2R5S ELECTRICAL CHARACTERISTICS

Parameter	Min.	Typ.	Max.	Units	Notes & Conditions	Group A Subgroup (see Note 11)
Specifications subject to change without notice					Vin=28V dc ±5%, Iout=8A, CL=0μF, free running (see Note 9) unless otherwise specified	
ABSOLUTE MAXIMUM RATINGS						
Input Voltage						
Non-Operating			60	V		
Operating			60	V	See Note 1	
Reverse Bias (Tcase = 125°C)			-0.8	V		
Reverse Bias (Tcase = -55°C)			-1.2	V		
Isolation Voltage (I/O to case, I to O)						
Continuous	-500		500	V		
Transient (≤100μs)	-800		800	V		
Operating Case Temperature	-55		125	°C	HB Grade Products, See Notes 2 & 13	
Storage Case Temperature	-65		135	°C		
Lead Temperature (20s)			300	°C		
Voltage at ENA1	-1.2		50	V		
INPUT CHARACTERISTICS						
Operating Input Voltage Range	16	28	40	V	Continuous	1, 2, 3
"	16	28	50	V	Transient, 1s	
Input Under-Voltage Shutdown					See Note 3	
Turn-On Voltage Threshold	14.75	15.50	16.00	V		1, 2, 3
Turn-Off Voltage Threshold	14.00	14.75	15.50	V		1, 2, 3
Shutdown Voltage Hysteresis	0.65	0.85	1.05	V		
Input Over-Voltage Shutdown					See Note 3	
Turn-Off Voltage Threshold	52.0	55.0	58.0	V		
Turn-On Voltage Threshold	50.5	54.0	56.5	V		
Shutdown Voltage Hysteresis	0.8	1.9	3.0	V		
Input Filter Component Values (L/C)		2.2\6.4		μH\μF	Internal Values	
Maximum Input Current			1.65	A	Vin = 16V; Iout = 8A	
No Load Input Current (operating)		40	75	mA		1, 2, 3
Disabled Input Current		10	17	mA		1, 2, 3
Input Terminal Current Ripple (pk-pk)		25	50	mA	Bandwidth = 100kHz – 10MHz; see Figure 14	1, 2, 3
OUTPUT CHARACTERISTICS						
Output Voltage Set Point (Tcase = 25°C)	2.47	2.50	2.53	V	Vout at sense leads	1
Output Voltage Set Point Over Temperature	2.46	2.50	2.54	V	"	2, 3
Output Voltage Line Regulation	-40	0	40	mV	"	1, 2, 3
Output Voltage Load Regulation	-40	0	40	mV	" ; Vout @ (Iout=0A) - Vout @ (Iout=8A)	1, 2, 3
Total Output Voltage Range	2.45	2.50	2.55	V	"	1, 2, 3
Output Over-Voltage Shutdown	2.99	3.26	3.78	V		See Note 5
Output Voltage Ripple and Noise Peak to Peak		15	50	mV	Bandwidth = 10MHz; CL=11μF	1, 2, 3
Operating Output Current Range	0		8	A		1, 2, 3
Operating Output Power Range	0		20	W		1, 2, 3
Output DC Current-Limit Inception	8.2	10.3	12.4	A	See Note 4	1, 2, 3
Back-Drive Current Limit while Enabled		2		A		1, 2, 3
Back-Drive Current Limit while Disabled		10	50	mA		1, 2, 3
Maximum Output Capacitance			2,000	μF		See Note 5
DYNAMIC CHARACTERISTICS						
Output Voltage Deviation Load Transient					See Note 6	
For a Pos. Step Change in Load Current	-250	-100		mV	Total Iout step = 4A to 8A, 0.8A to 4A; CL=11μF	4, 5, 6
For a Neg. Step Change in Load Current		100	250	mV	"	4, 5, 6
Output Voltage Deviation Line Transient					Vin step = 17V to 50V; CL=11μF; see Note 7	
For a Pos. Step Change in Line Voltage	-125		125	mV		
For a Neg. Step Change in Line Voltage	-125		125	mV		
Turn-On Transient						
Output Voltage Rise Time		6	10	ms	Vout = 0.25V to 2.25V; Full Resistive Load	4, 5, 6
Output Voltage Overshoot		0	2	%	Resistive load	See Note 5
Turn-On Delay, Rising Vin		5.5	8.0	ms	ENA = 5V; see Notes 8 & 10	4, 5, 6
Turn-On Delay, Rising ENA		3.0	6.0	ms	See Note 10	4, 5, 6
Restart Inhibit Time		100	150	ms	See Note 10	4, 5, 6
Short Circuit Start Time	12	14	20	ms	Duration of pulse width, see Figure 16	4
EFFICIENCY						
Iout = 8 A (16 Vin)	78	82		%		
Iout = 4 A (16 Vin)	82	85		%		
Iout = 8 A (28 Vin)	77	81		%		1, 2, 3
Iout = 4 A (28 Vin)	80	83		%		
Iout = 8 A (40 Vin)	76	80		%		
Iout = 4 A (40 Vin)	78	81		%		
Iout = 8 A (50 Vin)	75	79		%		
Load Fault Power Dissipation		1.3		W	Sustained short circuit on output	

Technical Specification

MQBL-28-2R5S ELECTRICAL CHARACTERISTICS (Continued)

Parameter	Min.	Typ.	Max.	Units	Notes & Conditions	Group A Subgroup
Specifications subject to change without notice						
Vin=28V dc ±5%, Iout=8A, CL=0μF, free running (see Note 9) unless otherwise specified						
ISOLATION CHARACTERISTICS						
Isolation Voltage					Dielectric strength	
Input RTN to Output RTN	500			V		1
Any Input Pin to Case	500			V		1
Any Output Pin to Case	500			V		1
Isolation Resistance (in rtn to out rtn)	100			MΩ		1
Isolation Resistance (any pin to case)	100			MΩ		1
Isolation Capacitance (in rtn to out rtn)		22		nF		1
FEATURE CHARACTERISTICS						
Switching Frequency (free running)	500	550	600	kHz		1, 2, 3
Synchronization Input						
Frequency Range	500		700	kHz		1, 2, 3
Logic Level High	2.0		5.5	V		1, 2, 3
Logic Level Low	-0.5		0.8	V		1, 2, 3
Duty Cycle	20		80	%		See Note 5
Synchronization Output						
Pull Down Current	20			mA	VSYNC OUT = 0.8V	See Note 5
Duty Cycle	40		60	%	Output connected to SYNC IN of other MQBL unit	See Note 5
Enable Control (ENA)						
Off-State Voltage			0.8	V		1, 2, 3
Module Off Pulldown Current	80			μA	Current drain required to ensure module is off	See Note 5
On-State Voltage	2			V		1, 2, 3
Module On Pin Leakage Current			20	μA	Imax draw from pin allowed with module still on	See Note 5
Pull-Up Voltage	3.2	4.0	4.8	V	See Figure A	
Output Voltage Trim Range	-10		10	%	See Figure E	1, 2, 3
RELIABILITY CHARACTERISTICS						
Calculated MTBF (MIL-STD-217F2)						
GB @ Tcase = 70°C		2540		10 ³ Hrs.		
AIF @ Tcase = 70°C		192		10 ³ Hrs.		
WEIGHT CHARACTERISTICS						
Device Weight		35		g		

Electrical Characteristics Notes

1. Converter will undergo input over-voltage shutdown.
2. Derate output power for continuous operation per Figure 5.
3. High or low state of input voltage must persist for about 200μs to be acted on by the shutdown circuitry.
4. Current limit inception is defined as the point where the output voltage has dropped to 90% of its nominal value. See Current Limit discussion in Features Description section.
5. Parameter not tested but guaranteed to the limit specified.
6. Load current transition time ≥ 10μs.
7. Line voltage transition time ≥ 100μs.
8. Input voltage rise time ≤ 250μs.
9. Operating the converter at a synchronization frequency above the free running frequency will cause the converter's efficiency to be slightly reduced and it may also cause a slight reduction in the maximum output current/power available. For more information consult the factory.
10. After a disable or fault event, module is inhibited from restarting for 100ms. See Shut Down section of the Control Features description.
11. Only the ES and HB grade products are tested at three temperatures. The C grade products are tested at one temperature. Please refer to the Construction and Environmental Stress Screening Options table for details.
12. These derating curves apply for the ES and HB grade products. The C grade product has a maximum case temperature of 70°C.
13. The specified operating case temperature for ES grade products is -45°C to 100°C. The specified operating case temperature for C grade products is 0°C to 70°C.



MQBL-28-2R5S
Output: 2.5V
Current: 8A

Technical Figures

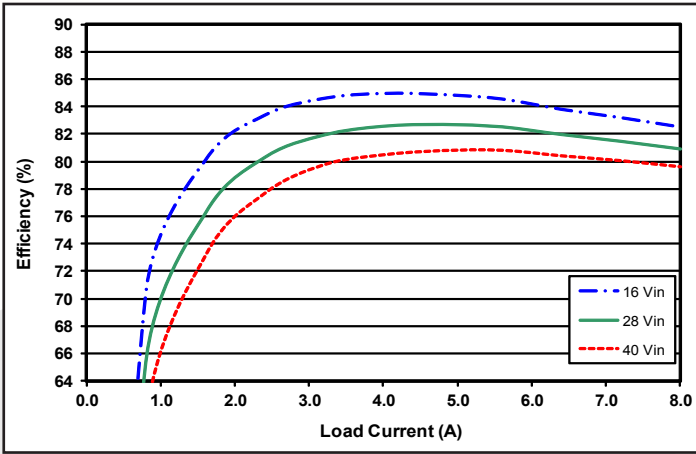

Figure 1: Efficiency at nominal output voltage vs. load current for minimum, nominal, and maximum input voltage at Tcase=25°C.

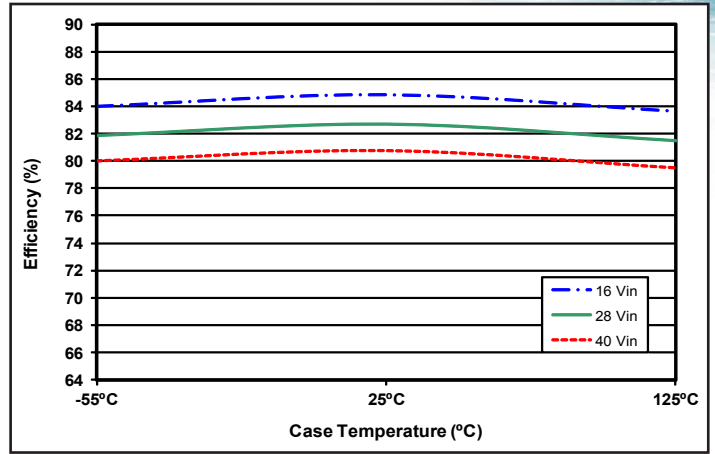

Figure 2: Efficiency at nominal output voltage and 60% rated power vs. case temperature for input voltage of 16V, 28V, and 40V.

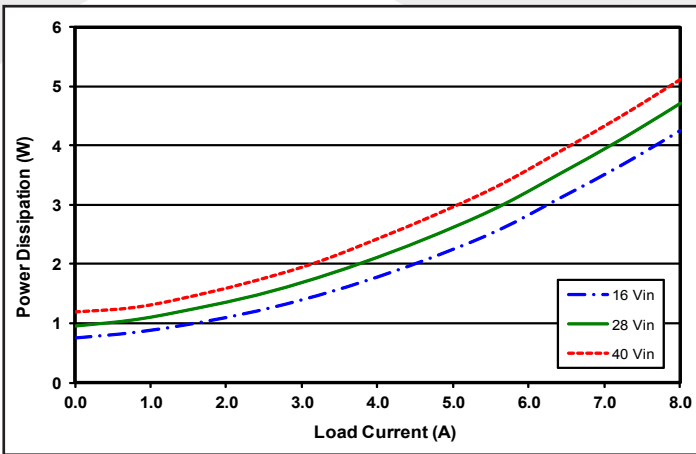

Figure 3: Power dissipation at nominal output voltage vs. load current for minimum, nominal, and maximum input voltage at Tcase=25°C.

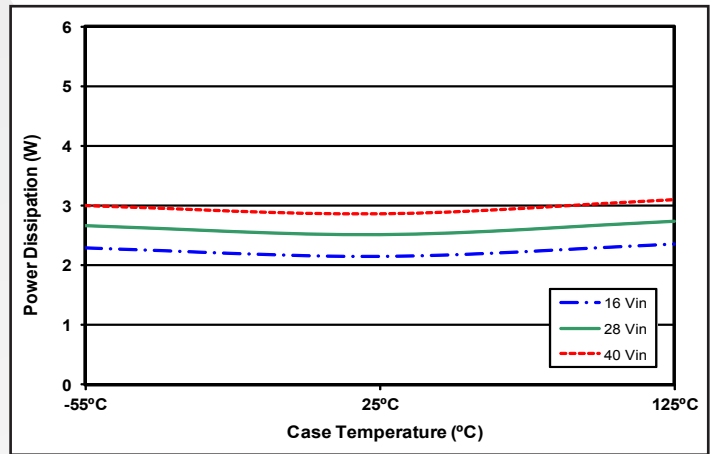

Figure 4: Power dissipation at nominal output voltage and 60% rated power vs. case temperature for input voltage of 16V, 28V, and 40V.

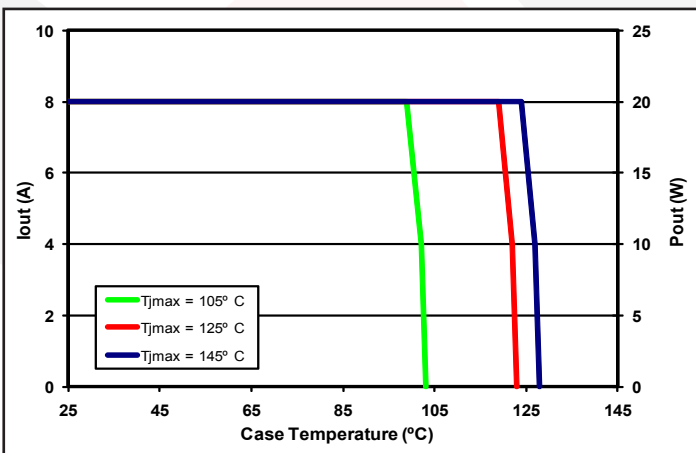

Figure 5: Output Current / Output Power derating curve as a function of Tcase and the Maximum desired power MOSFET junction temperature at Vin = 28V (see Note 12).

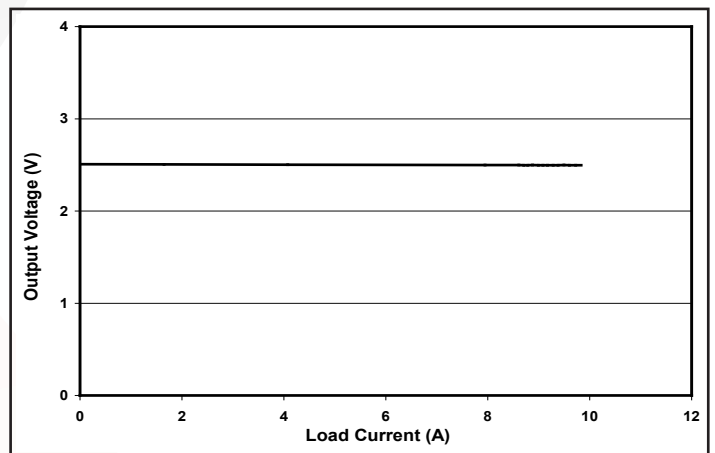

Figure 6: Output voltage vs. load current showing typical current limit curves at Vin = 28V.



MQBL-28-2R5S

Output: 2.5V

Current: 8A

Technical Figures

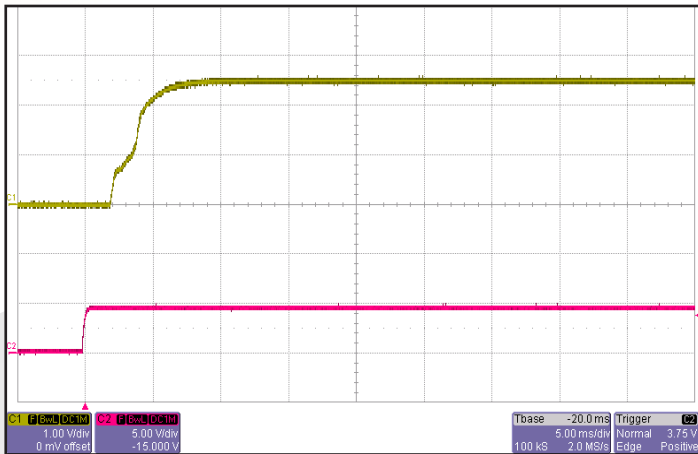

Figure 7: Turn-on transient at full resistive load and zero output capacitance initiated by ENA1. Input voltage pre-applied. Ch 1: Vout (1V/div). Ch 2: ENA1 (5V/div).

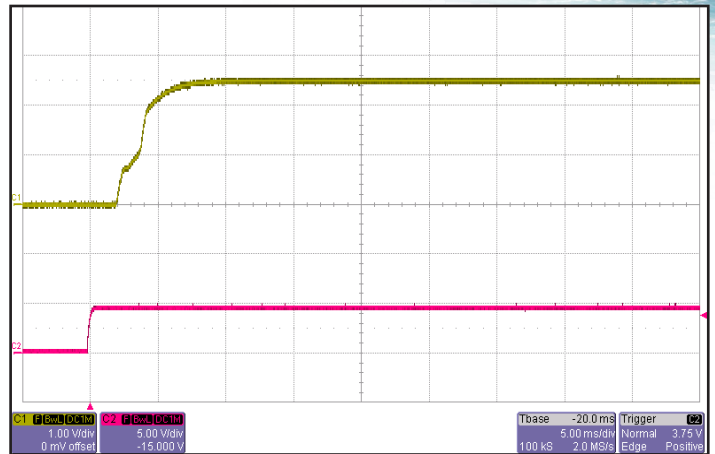

Figure 8: Turn-on transient at full resistive load and 2mF output capacitance initiated by ENA1. Input voltage pre-applied. Ch 1: Vout (1V/div). Ch 2: ENA1 (5V/div).

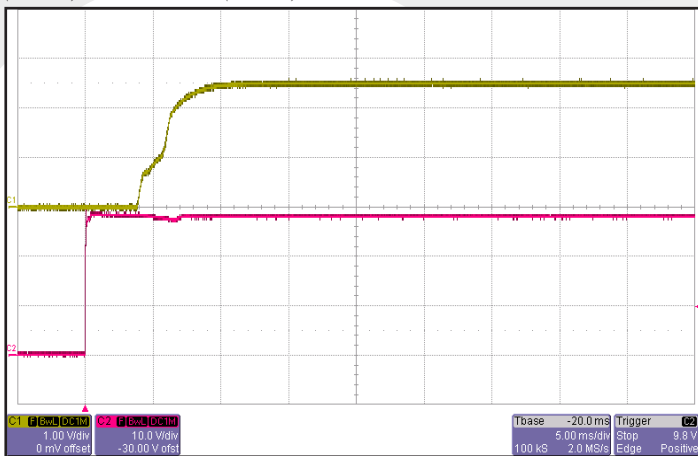

Figure 9: Turn-on transient at full resistive load and zero output capacitance initiated by Vin. ENA1 previously high. Ch 1: Vout (1V/div). Ch 2: Vin (10V/div).

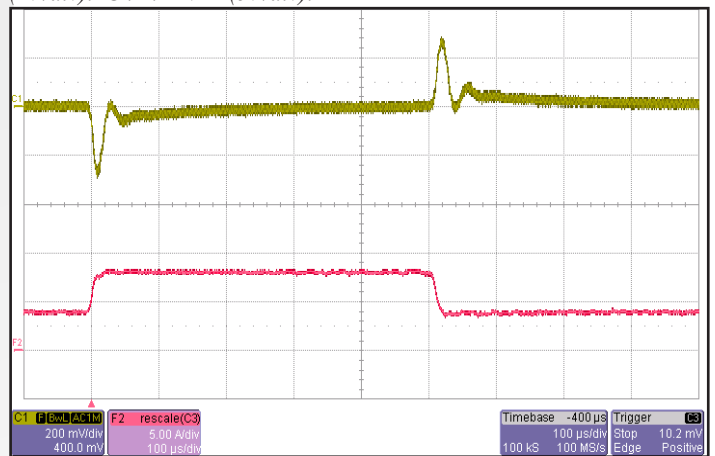

Figure 10: Output voltage response to step-change in load current 50%-100%-50% of Iout (max). Load cap: 1µF ceramic cap and 10µF, 100mΩ ESR tantalum cap. Ch 1: Vout (200mV/div). Ch 2: Iout (5A/div).

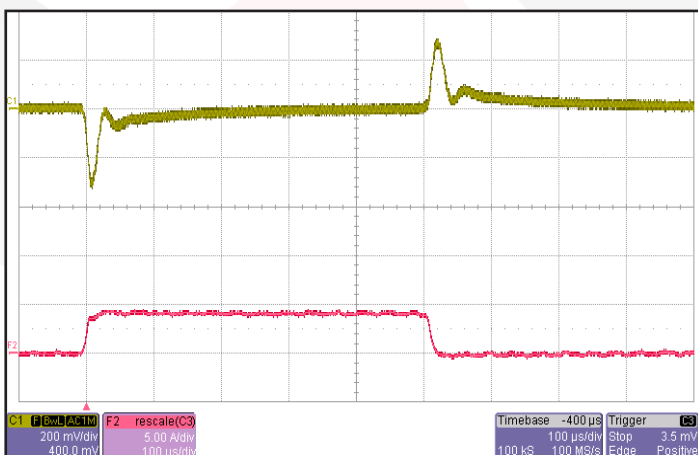

Figure 11: Output voltage response to step-change in load current 0%-50%-0% of Iout (max). Load cap: 1µF ceramic cap and 10µF, 100mΩ ESR tantalum cap. Ch 1: Vout (200mV/div). Ch 2: Iout (5A/div).

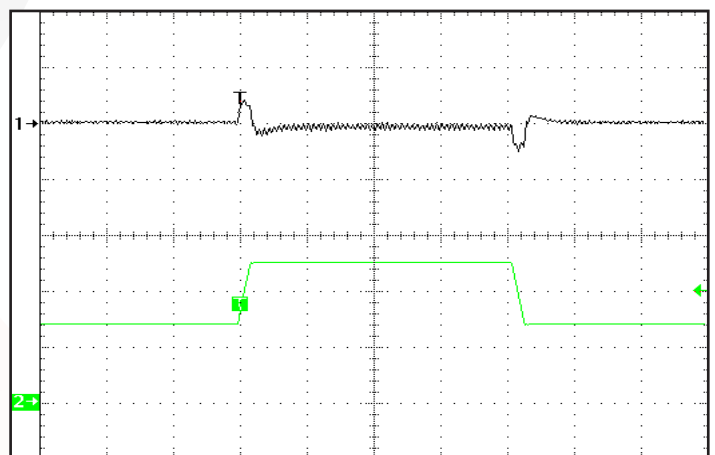

Figure 12: Output voltage response to step-change in input voltage (28V - 50V - 28V) in 150µs. Ch 1: Vout (50mV/div). Ch 2: Vin (20V/div).



MQBL-28-2R5S

Output: 2.5V

Current: 8A

Technical Figures

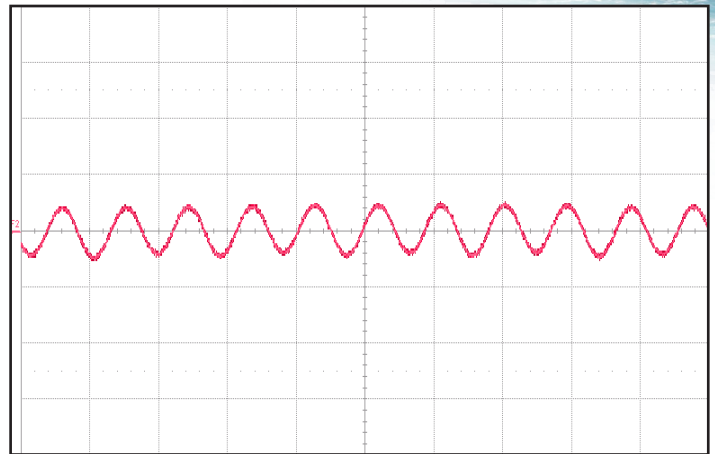
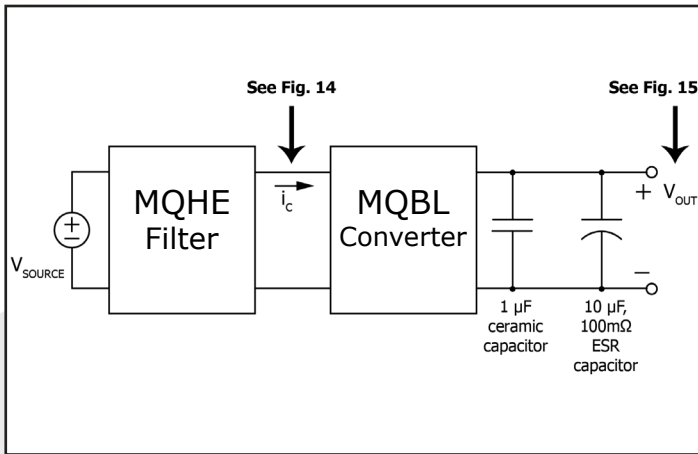

Figure 13: Test set-up diagram showing measurement points for Input Terminal Ripple Current (Figure 14) and Output Voltage Ripple (Figure 15).

Figure 14: Input terminal current ripple, i_c , at full rated output current and nominal input voltage with SynQor MQ filter module (50mA/div). Bandwidth: 20MHz. See Figure 13.

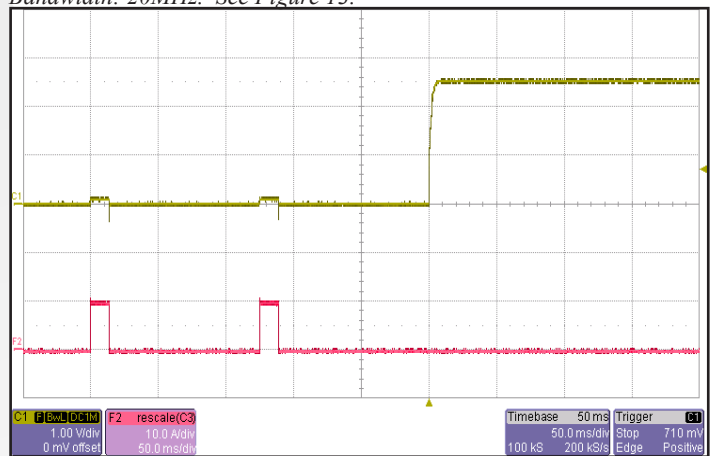
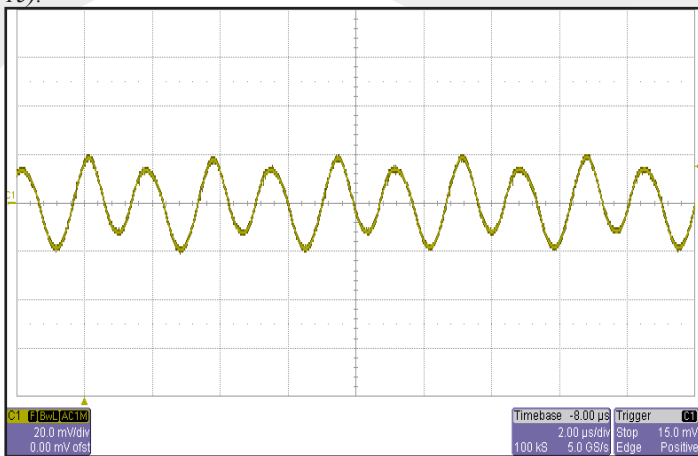

Figure 15: Output voltage ripple, V_{out} , at nominal input voltage and rated load current (20mV/div). Load capacitance: 1 μF ceramic capacitor and 10 μF tantalum capacitor. Bandwidth: 10MHz. See Figure 13.

Figure 16: Rise of output voltage after the removal of a short circuit across the output terminals. Ch 1: V_{out} (1V/div). F 2: I_{out} (10A/div).

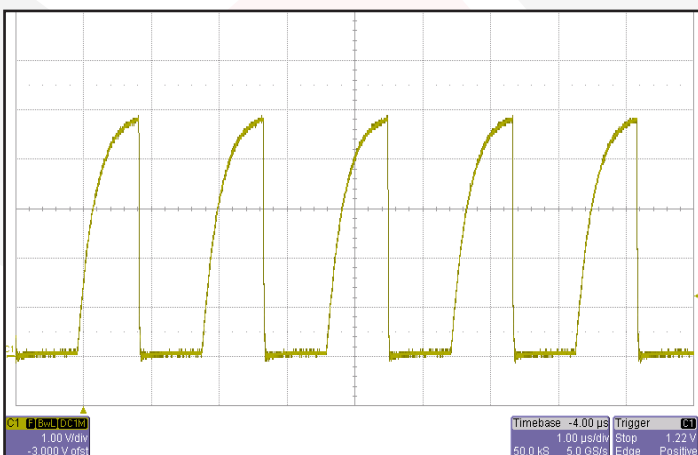

Figure 17: SYNC OUT vs. time, driving SYNC IN of a second SynQor MQBL converter. Ch1: SYNC OUT: (1V/div).



MQBL-28-2R5S

Output: 2.5V

Current: 8A

Technical Figures

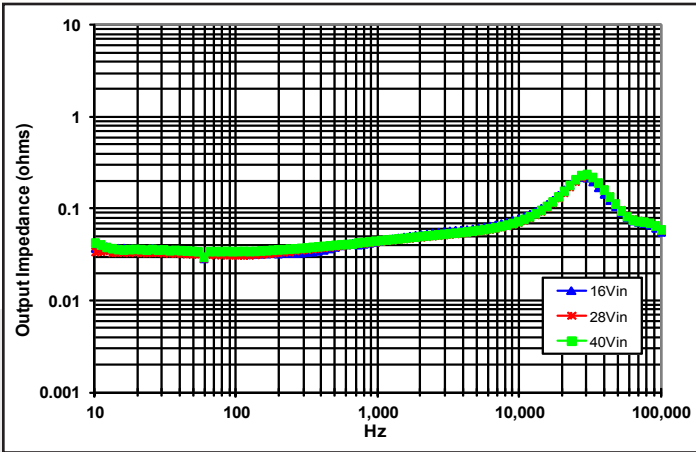

Figure 18: Magnitude of incremental output impedance ($Z_{out} = v_{out}/i_{out}$) for minimum, nominal, and maximum input voltage at full rated power.

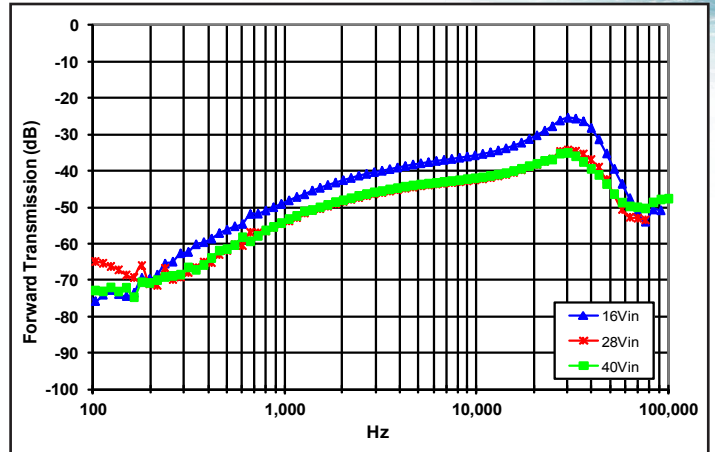

Figure 19: Magnitude of incremental forward transmission ($FT = v_{out}/v_{in}$) for minimum, nominal, and maximum input voltage at full rated power.

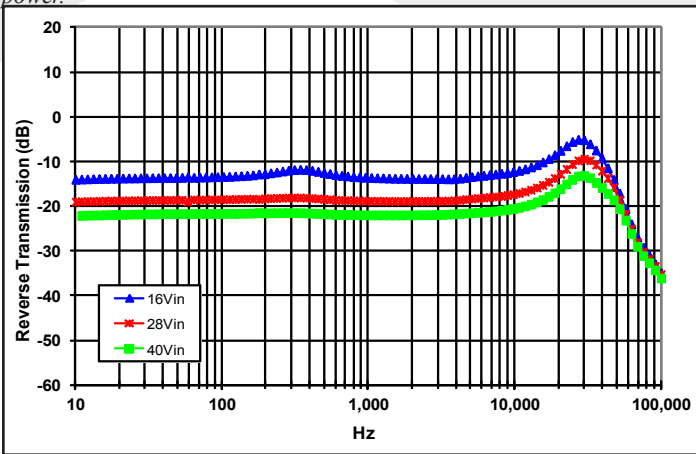

Figure 20: Magnitude of incremental reverse transmission ($RT = i_{in}/i_{out}$) for minimum, nominal, and maximum input voltage at full rated power.

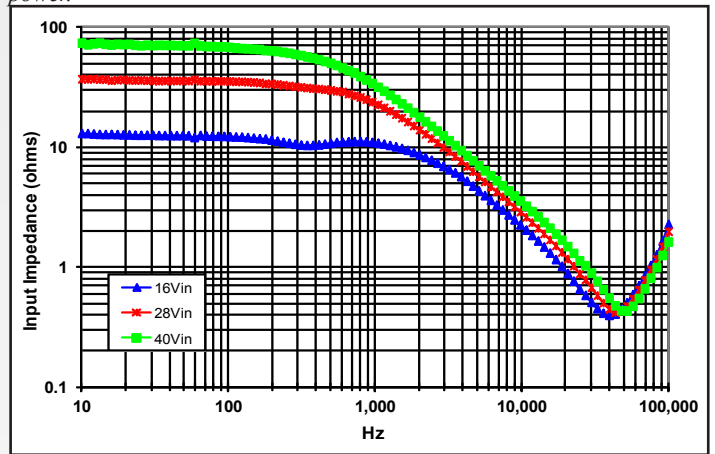

Figure 21: Magnitude of incremental input impedance ($Z_{in} = v_{in}/i_{in}$) for minimum, nominal, and maximum input voltage at full rated power.

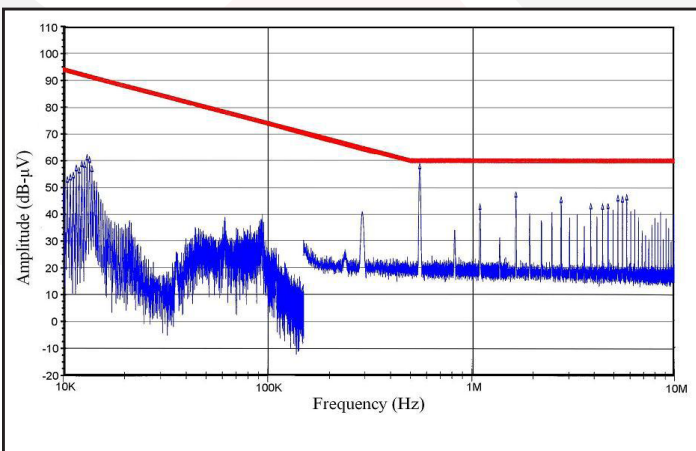

Figure 22: High frequency conducted emissions of standalone MQHL-28-05S, 5V_{out} module at 50W output, as measured with Method CE102. Limit line shown is the 'Basic Curve' for all applications with a 28V source.

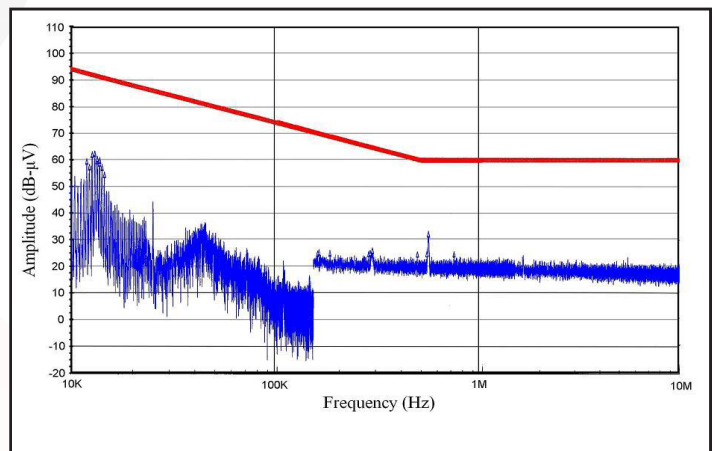

Figure 24: High frequency conducted emissions of MQHL-28-05S, 5V_{out} module at 50W output with MQHE-28-P filter, as measured with Method CE102. Limit line shown is the 'Basic Curve' for all applications with a 28V source.



MQBL-28-2R5S

Output: 2.5V

Current: 8A

Application Section

BASIC OPERATION AND FEATURES

The MQBL DC/DC converter uses a two-stage power conversion topology. The first, or regulation, stage is a buck-converter that keeps the output voltage constant over variations in line, load, and temperature. The second, or isolation, stage uses transformers to provide the functions of input/output isolation and voltage transformation to achieve the output voltage required.

Both the regulation and the isolation stages switch at a fixed frequency for predictable EMI performance. The isolation stage switches at one half the frequency of the regulation stage, but due to the push-pull nature of this stage it creates a ripple at double its switching frequency. As a result, both the input and the output of the converter have a fundamental ripple frequency of about 550 kHz in the free-running mode.

Rectification of the isolation stage's output is accomplished with synchronous rectifiers. These devices, which are MOSFETs with a very low resistance, dissipate far less energy than would Schottky diodes. This is the primary reason why the MQBL converters have such high efficiency, particularly at low output voltages.

Besides improving efficiency, the synchronous rectifiers permit operation down to zero load current. There is no longer a need for a minimum load, as is typical for converters that use diodes for rectification. The synchronous rectifiers actually permit a negative load current to flow back into the converter's output terminals if the load is a source of short or long term energy. The MQBL converters employ a "back-drive current limit" to keep this negative output terminal current small.

There is a control circuit in the MQBL converter that determines the conduction state of the power switches. It communicates across the isolation barrier through a magnetically coupled device. No opto-isolators are used.

An input under-voltage shutdown feature with hysteresis is provided, as well as an input over-voltage shutdown and an output over-voltage limit. There is also an output current limit that is nearly constant as the load impedance decreases (i.e., there is not fold-back or fold-forward characteristic to the output current under this condition). When a load fault is removed, the output voltage rises exponentially to its nominal value without an overshoot. If a load fault pulls the output voltage below about 60% of nominal, the converter will shut down to attempt to clear the load fault. After a short delay it will try to auto-restart.

The MQBL converter's control circuit does not implement an over-temperature shutdown.

The following sections describe the use and operation of additional control features provided by the MQBL converter.

CONTROL FEATURES

ENABLE: The MQBL converter has one enable pin, ENA1 (pin 4), which is referenced with respect to the converter's input return (pin 2). It must have a logic high level for the converter to be enabled; a logic low inhibits the converter.

The enable pin is internally pulled high so that an open connection will enable the converter. Figure A shows the equivalent circuit looking into the enable pin. It is TTL compatible and has hysteresis.

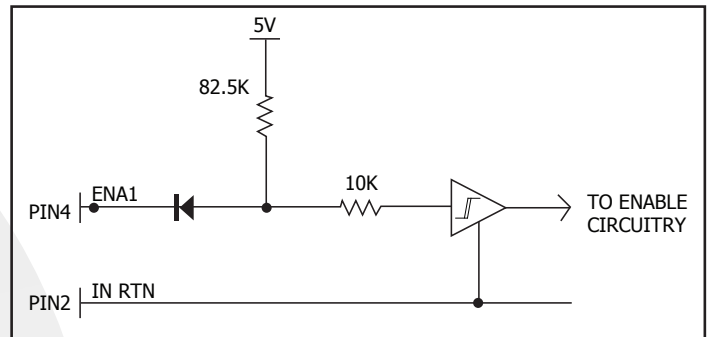

Figure A: Circuit diagram shown for reference only, actual circuit components may differ from values shown for equivalent circuit.

SHUT DOWN: The MQBL converter will shut down in response to only five conditions: ENA input low, VIN input below under-voltage shutdown threshold, VIN input above over-voltage shutdown threshold, output voltage below the output under-voltage threshold, and output voltage above the output over-voltage threshold. Following any shutdown event, there is a startup inhibit delay which will prevent the converter from restarting for approximately 100ms. After the 100ms delay elapses, if the enable inputs are high and the input voltage is within the operating range, the converter will restart. If the VIN input is brought down to nearly 0V and back into the operating range, there is no startup inhibit, and the output voltage will rise according to the "Turn-On Delay, Rising Vin" specification.

REMOTE SENSE: The purpose of the remote sense pins is to correct for the voltage drop along the conductors that connect the converter's output to the load. To achieve this goal, a separate conductor should be used to connect the +SENSE pin (pin 10) directly to the positive terminal of the load, as shown in the connection diagram on Page 2. Similarly, the -SENSE pin (pin 9) should be connected through a separate conductor to the return terminal of the load.

NOTE: Even if remote sensing of the load voltage is not desired, the +SENSE and the -SENSE pins must be connected to +Vout (pin 7) and OUTPUT RETURN (pin 8), respectively, to get proper regulation of the converter's output. If they are left open, the converter will have an output voltage that is approximately 200mV higher than its specified value.



MQBL-28-2R5S

Output: 2.5V

Current: 8A

Application Section

Inside the converter, +SENSE is connected to +Vout with a 100Ω resistor and -SENSE is connected to OUTPUT RETURN with a 10Ω resistor.

It is also important to note that when remote sense is used, the voltage across the converter's output terminals (pins 7 and 8) will be higher than the converter's nominal output voltage due to resistive drops along the connecting wires. This higher voltage at the terminals produces a greater voltage stress on the converter's internal components and may cause the converter to fail to deliver the desired output voltage at the low end of the input voltage range at the higher end of the load current and temperature range. Please consult the factory for details.

SYNCHRONIZATION: The MQBL converter's switching frequency can be synchronized to an external frequency source that is in the 500 kHz to 700 kHz range. A pulse train at the desired frequency should be applied to the SYNC IN pin (pin 6) with respect to the INPUT RETURN (pin 2). This pulse train should have a duty cycle in the 20% to 80% range. Its low value should be below 0.8V to be guaranteed to be interpreted as a logic low, and its high value should be above 2.0V to be guaranteed to be interpreted as a logic high. The transition time between the two states should be less than 300ns.

If the MQBL converter is not to be synchronized, the SYNC IN pin should be left open circuit. The converter will then operate in its free-running mode at a frequency of approximately 550 kHz.

If, due to a fault, the SYNC IN pin is held in either a logic low or logic high state continuously, or the SYNC IN frequency is outside the 500-700 kHz range, the MQBL converter will revert to its free-running frequency.

The MQBL converter also has a SYNC OUT pin (pin 5). This output can be used to drive the SYNC IN pins of as many as ten (10) other MQBL converters. The pulse train coming out of SYNC OUT has a duty cycle of 50% and a frequency that matches the switching frequency of the converter with which it is associated. This frequency is either the free-running frequency if there is no valid synchronization signal at the SYNC IN pin, or the synchronization frequency if there is.

The synchronization feature is entirely compatible with that of SynQor's MQFL family of converters.

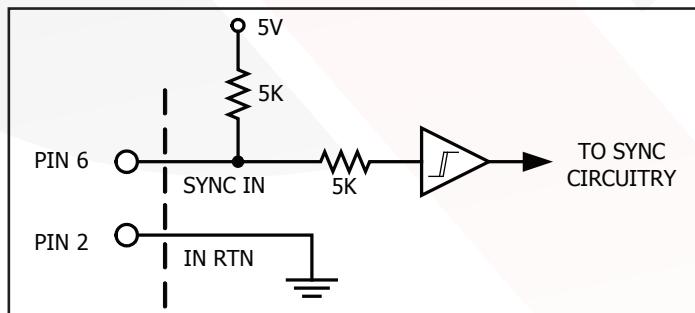

Figure B: Equivalent circuit looking into the SYNC IN pin with respect to the IN RTN (input return) pin.

Figure B shows the equivalent circuit looking into the SYNC IN pin and Figure C shows the equivalent circuit looking into the SYNC OUT pin.

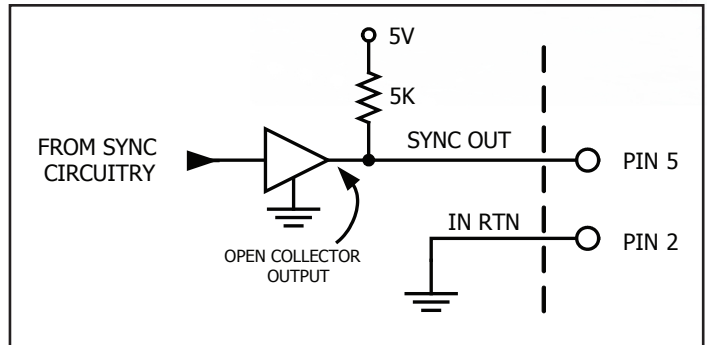

Figure C: Equivalent circuit looking into SYNC OUT pin with respect to the IN RTN (input return) pin.

OUTPUT VOLTAGE TRIM: the TRIM pin (pin 11) can adjust the MQBL converter's output voltage $\pm 10\%$ around its nominal value.

To trim the output voltage above its nominal value, connect an external resistor from the TRIM pin to the -SENSE pin as shown in Figure D. The value of this trim up resistor should be chosen according to the following equation or from Figure E:

$$R_{\text{trim up}}(\Omega) = \frac{6100\Omega \cdot V_{\text{nom}}}{V_{\text{out}} - V_{\text{nom}}} - 30000\Omega$$

where:

V_{nom} = the converter's nominal output voltage,
 V_{out} = the desired output voltage (greater than V_{nom}), and
 $R_{\text{trim up}}$ is in Ohms.

As the output voltage is trimmed up, it produces a greater voltage stress on the converter's internal components and may cause the converter to fail to deliver the desired output voltage at the low end of the input voltage range at the higher end of the load current and temperature range. Please consult the factory for details. To trim the output voltage below its nominal value, connect an external resistor between the TRIM pin and the +SENSE pin. The value of this trim down resistor should be chosen according to the following equation or from Figure E:

$$R_{\text{trim down}}(\Omega) = \frac{15400\Omega \cdot V_{\text{out}} - 6100\Omega \cdot V_{\text{nom}}}{V_{\text{nom}} - V_{\text{out}}} - 30000\Omega$$

where:

V_{nom} = the converter's nominal output voltage,
 V_{out} = the desired output voltage (less than V_{nom}), and
 $R_{\text{trim down}}$ is in Ohms.



MQBL-28-2R5S

Output: 2.5V

Current: 8A

Application Section

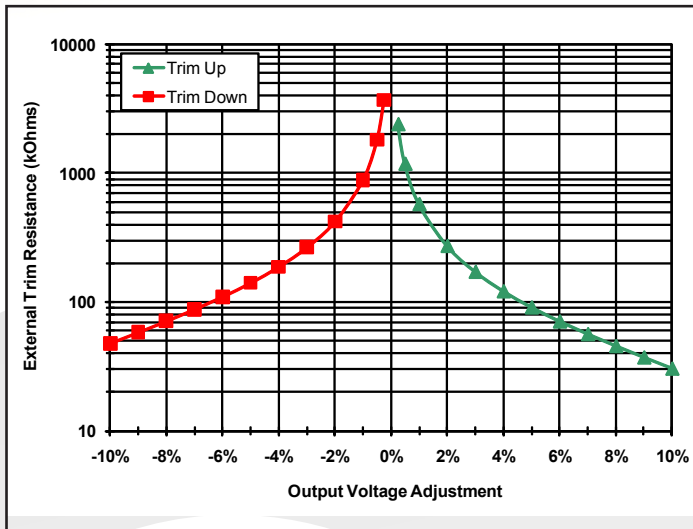

Figure E: Trim up and Trim down as a function of external trim resistance.

INPUT UNDER-VOLTAGE SHUTDOWN: The MQBL converter has an under-voltage shutdown feature that ensures the converter will be off if the input voltage is too low. The input voltage turn-on threshold is higher than the turn-off threshold. In addition, the MQBL converter will not respond to a state of the input voltage unless it has remained in that state for more than about 200µs. This hysteresis and the delay ensure proper operation when the source impedance is high or in a noisy environment.

INPUT OVER-VOLTAGE SHUTDOWN: The MQBL converter also has an over-voltage feature that ensures the converter will be off if the input voltage is too high. It also has a hysteresis and time delay to ensure proper operation.

OUTPUT OVER-VOLTAGE SHUTDOWN: The MQBL converter will shut down if the voltage at its power output pins ever exceeds about 130% of the nominal value. The

shutdown threshold does not change with output trim or sense drops; excessive trim-up or output wiring drops may cause an output over-voltage shutdown event. After a startup inhibit delay, the converter will attempt to restart.

OUTPUT UNDER-VOLTAGE SHUTDOWN: The MQBL converter will also shut down if the voltage at its power output pins ever dips below 60% of the nominal value for more than a few milliseconds. Output voltage reduction due to output current overload (current limit) is the most common trigger for this shutdown. The shutdown threshold does not change with output trim but at only 10%, trim-down should not trigger this event. After a startup inhibit delay, the converter will attempt to restart. This shutdown is disabled during startup.

BACK-DRIVE CURRENT LIMIT: Converters that use MOSFETs as synchronous rectifiers are capable of drawing a negative current from the load if the load is a source of short- or long-term energy. This negative current is referred to as a "back-drive current".

Conditions where back-drive current might occur include paralleled converters that do not employ current sharing. It can also occur when converters having different output voltages are connected together through either explicit or parasitic diodes that, while normally off, become conductive during startup or shutdown. Finally, some loads, such as motors, can return energy to their power rail. Even a load capacitor is a source of back-drive energy for some period of time during a shutdown transient.

To avoid any problems that might arise due to back-drive current, the MQBL converters limit the negative current that the converter can draw from its output terminals. The threshold for this back-drive current limit is placed sufficiently below zero so that the converter may operate properly down to zero load, but its absolute value (see the Electrical Characteristics page) is small compared to the converter's rated output current.

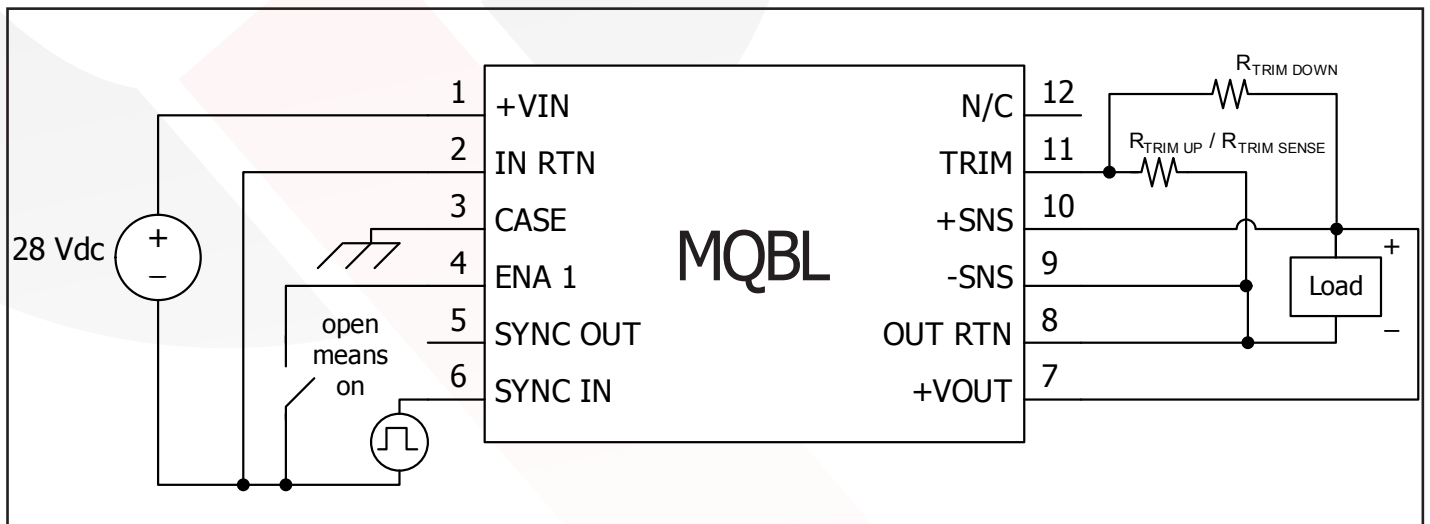

Figure D: Typical connection for output voltage trimming.



MQBL-28-2R5S

Output: 2.5V

Current: 8A

Application Section

CURRENT LIMIT: In the event of excess load, the MQBL converter will quickly reduce its output voltage to keep the load current within safe limits (see Figure 6). If the overload persists for more than 14 milliseconds, the converter will shut off, wait a restart delay, and then automatically attempt to re-start. The timeout is internally implemented with an integrator: counting up whenever current limit is active, and counting down at 1/5th the rate whenever current limit becomes inactive. In this way a series of short-duration overloads will not cause the converter to shut down, while it will shut down in response to sustained overloads.

THERMAL CONSIDERATIONS: Figure 5 shows the suggested Power Derating Curves for this converter as a function of the case temperature and the maximum desired power MOSFET junction temperature. All other components within the converter are cooler than its hottest MOSFET, which at full power is no more than 20°C higher than the case temperature directly below this MOSFET.

The Mil-HDBK-1547A component derating guideline calls for a maximum component temperature of 105°C. Figure 5 therefore has one power derating curve that ensures this limit is maintained. It has been SynQor's extensive experience that reliable long-term converter operation can be achieved with a maximum component temperature of 125°C. In extreme cases, a maximum temperature of 145°C is permissible, but not recommended for long-term operation where high reliability is required. Derating curves for these higher temperature limits are also included in Figure 5. The maximum case temperature at which the converter should be operated is 135°C.

When the converter is mounted on a metal plate, the plate will help to make the converter's case bottom a uniform temperature. How well it does so depends on the thickness of the plate and on the thermal conductance of the interface layer (e.g. thermal grease, thermal pad, etc.) between the case and the plate. Unless this is done very well, it is important not to mistake the plate's temperature for the maximum case temperature. It is easy for them to be as much as 5-10°C different at full power and at high temperatures. It is suggested that a thermocouple be attached directly to the converter's case through a small hole in the plate when investigating how hot the converter is getting. Care must also be made to ensure that there is not a large thermal resistance between the thermocouple and the case due to whatever adhesive might be used to hold the thermocouple in place.

INPUT SYSTEM INSTABILITY: This condition can occur because any dc-dc converter appears incrementally as a negative resistance load. A detailed application note titled "Input System Instability" is available on the SynQor website which provides an understanding of why this instability arises, and shows the preferred solution for correcting it.



MQBL-28-2R5S

Output: 2.5V

Current: 8A

CONSTRUCTION AND ENVIRONMENTAL STRESS SCREENING OPTIONS

Screening	Consistent with MIL-STD-883F	C-Grade (specified from 0 °C to +70 °C)	ES-Grade (specified from -45 °C to +100 °C)	HB-Grade (specified from -55 °C to +125 °C)
Element Evaluation		No	Yes	Yes
Internal Visual	*	Yes	Yes	Yes
Temperature Cycle	Method 1010	No	Condition B (-55 °C to +125 °C)	Condition C (-65 °C to +150 °C)
Constant Acceleration	Method 2001 (Y1 Direction)	No	500g	Condition A (5000g)
Burn-in	Method 1015	24 Hrs @ +125 °C	96 Hrs @ +125 °C	160 Hrs @ +125 °C
Final Electrical Test	Method 5005 (Group A)	+25 °C	-45, +25, +100 °C	-55, +25, +125 °C
Mechanical Seal, Thermal, and Coating Process			Full QorSeal	Full QorSeal
External Visual	2009	*	Yes	Yes
Construction Process			QorSeal	QorSeal

* Per IPC-A-610 Class 3

MilQor® Hi-Rel converters and filters are offered in three variations of environmental stress screening options. All ES-Grade and HB-Grade MilQor Hi-Rel converters use SynQor's proprietary QorSeal® Hi-Rel assembly process that includes a Parylene-C coating of the circuit, a high performance thermal compound filler, and a nickel barrier gold plated aluminum case. Each successively higher grade has more stringent mechanical and electrical testing, as well as a longer burn-in cycle. The ES- and HB-Grades are also constructed of components that have been procured through an element evaluation process that pre-qualifies each new batch of devices.



MQBL-28-2R5S

Output: 2.5V

Current: 8A

Technical Specifications

MIL-STD-810F Qualification Testing

MIL-STD-810F Test	Method	Description
Fungus	508.5	Table 508.5-I
Altitude	500.4 - Procedure I	Storage: 70,000 ft / 2 hr duration
	500.4 - Procedure II	Operating: 70,000 ft / 2 hr duration; Ambient Temperature
Rapid Decompression	500.4 - Procedure III	Storage: 8,000 ft to 40,000 ft
Acceleration	513.5 - Procedure II	Operating: 15 g
Salt Fog	509.4	Storage
High Temperature	501.4 - Procedure I	Storage: 135°C / 3 hrs
	501.4 - Procedure II	Operating: 100°C / 3 hrs
Low Temperature	502.4 - Procedure I	Storage: -65°C / 4 hrs
	502.4 - Procedure II	Operating: -55°C / 3 hrs
Temperature Shock	503.4 - Procedure I - C	Storage: -65°C to 135°C; 12 cycles
Rain	506.4 - Procedure I	Wind Blown Rain
Immersion	512.4 - Procedure I	Non-Operating
Humidity	507.4 - Procedure II	Aggravated cycle @ 95% RH (Figure 507.5-7 aggravated temp - humidity cycle, 15 cycles)
Random Vibration	514.5 - Procedure I	10 - 2000 Hz, PSD level of 1.5 g ² /Hz (54.6 grms), duration = 1 hr/axis
Shock	516.5 - Procedure I	20 g peak, 11 ms, Functional Shock (Operating no load) (saw tooth)
	516.5 - Procedure VI	Bench Handling Shock
Sinusoidal vibration	514.5 - Category 14	Rotary wing aircraft - helicopter, 4 hrs/axis, 20 g (sine sweep from 10 - 500 Hz)
Sand and Dust	510.4 - Procedure I	Blowing Dust
	510.4 - Procedure II	Blowing Sand



MQBL-28-2R5S

Output: 2.5V

Current: 8A

Technical Specifications

First Article Testing consistent with MIL-STD-883F

MIL-STD-883F Test	Method	Description
Electrical Tests	5005	
Physical Dimensions test	2016	
Resistance to Solvents test	2015.13	
Solderability test	2003.8	
Lead Integrity test	2004.5	
Salt Atmosphere test	1009.8	Condition "A"
Adhesion of Lead Finish test	2025.4	
Altitude Operation test	1001	Condition "C"
ESD Sensitivity	3015.7	Class 2
Stabilization Bake test	1008.2	Condition "C"
Vibration Fatigue test	2005.2	Condition "A"
Random Vibration test	2026	Condition "II K"
Sequential Test Group #1		
Life Test – Steady State test	1005.8	
Life Test – Intermittent Duty test	1006	
Sequential Test Group #2		
Temperature Cycle test	1010.8	Condition "C"
Constant Acceleration test	2001.2	Condition "A"
Sequential Test Group #3		
Thermal Shock test	1011.9	Condition "B"
Temperature Cycle test	1010.8	Condition "C"
Moisture Resistance test	1004.7	With Sub cycle
Sequential Test Group #4		
Mechanical Shock test	2002.4	Condition "B"
Variable Frequency Vibration test	2007.3	Condition "A"



MQBL-28-2R5S

Output: 2.5V

Current: 8A

Mechanical Diagrams

PIN DESIGNATIONS

Pin #	Function
1	Positive input
2	Input return
3	Case
4	Enable 1
5	Sync output
6	Sync input
7	Positive output
8	Output return
9	- Sense
10	+ Sense
11	Trim
12	No connection

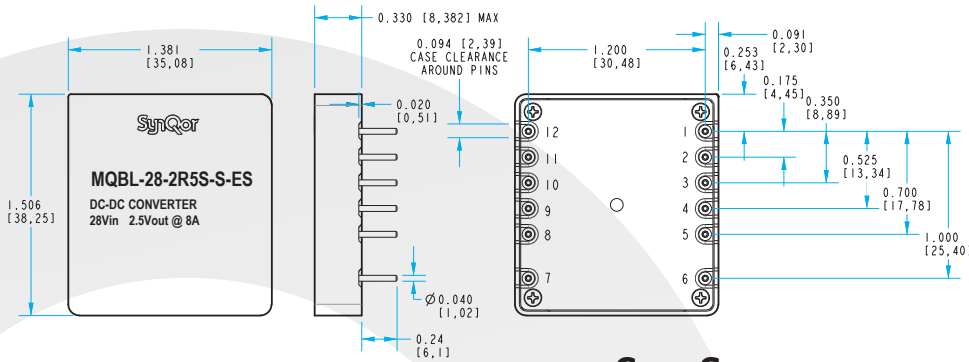

Case S

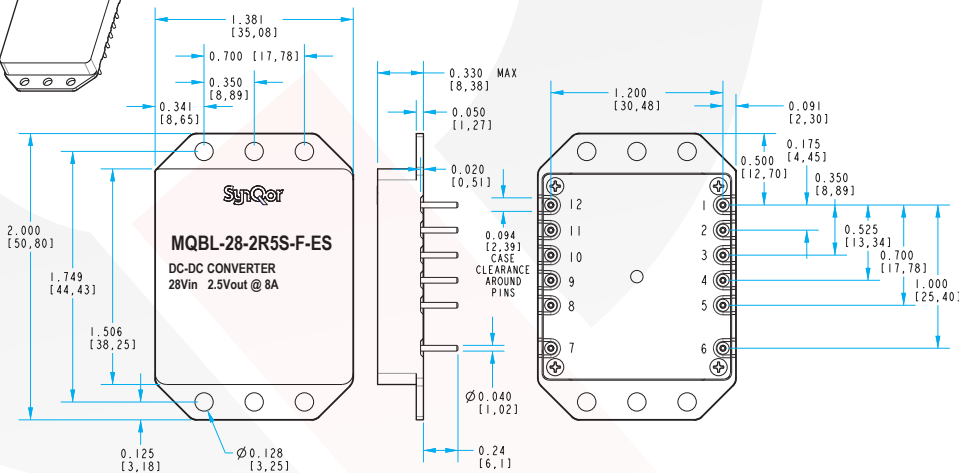
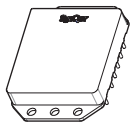

Case F

NOTES

- 1) Pins:
Diameter: 0.040" (1.02mm)
Material: Copper Alloy
Finish: Gold over Nickel plate
- 2) Case:
Material: Aluminum
Finish: Gold over Nickel plate
- 3) All dimensions are in inches (mm)
Tolerances: x.xx": +/-0.02"
(x.xmm: +/-0.5mm)
x.xxx": +/-0.010"
(x.xxmm +/-0.25mm)
- 4) Weight:
Standard: 1.17oz (33.3g)
Flanged: 1.24oz (35.1g)
- 5) Flanged version can be mounted using the 2 center holes or the 4 outer holes
- 6) Workmanship: Meets or exceeds IPC-A-610C Class III



MQBL-28-2R5S

Output: 2.5V

Current: 8A

Ordering Information

MilQor Converter FAMILY MATRIX

The tables below show the array of MilQor converters available. When ordering SynQor converters, please ensure that you use the complete part number according to the table in the last page. Contact the factory for other requirements.

	Single Output											Dual Output †		
	1.5V (1R5S)	1.8V (1R8S)	2.5V (2R5S)	3.3V (3R3S)	5V (05S)	6V (06S)	7.5V (7R5S)	9V (09S)	12V (12S)	15V (15S)	28V (28S)	5V (05D)	12V (12D)	15V (15D)
MQHL-28 16-40Vin Cont. 16-50Vin 1s Trans.* Absolute Max Vin = 60V	20A	20A	20A	15A	10A	8A	6.6A	5.5A	4A	3.3A	1.8A	10A Total	4A Total	3.3A Total
MQHL-28E 16-70Vin Cont. 16-80Vin 1s Trans.* Absolute Max Vin =100V	20A	20A	20A	15A	10A	8A	6.6A	5.5A	4A	3.3A	1.8A	10A Total	4A Total	3.3A Total
MQHR-28 16-40Vin Cont. 16-50Vin 1s Trans.* Absolute Max Vin = 60V	10A	10A	10A	7.5A	5A	4A	3.3A	2.75A	2A	1.65A	0.9A	5A Total	2A Total	1.65A Total
MQHR-28E 16-70Vin Cont. 16-80Vin 1s Trans.* Absolute Max Vin = 100V	10A	10A	10A	7.5A	5A	4A	3.3A	2.75A	2A	1.65A	0.9A	5A Total	2A Total	1.65A Total

	Single Output											Dual Output †		
	1.5V (1R5S)	1.8V (1R8S)	2.5V (2R5S)	3.3V (3R3S)	5V (05S)	6V (06S)	7.5V (7R5S)	9V (09S)	12V (12S)	15V (15S)	28V (28S)	5V (05D)	12V (12D)	15V (15D)
MQBL-28 16-40Vin Cont. 16-50Vin 1s Trans.* Absolute Max Vin = 60V	8A	8A	8A	6A	4A	3.3A	2.6A	2.2A	1.6A	1.3A	0.7A	4A Total	1.6A Total	1.3A Total
MQBL-28E 16-70Vin Cont. 16-80Vin 1s Trans.* Absolute Max Vin =100V	8A	8A	8A	6A	4A	3.3A	2.6A	2.2A	1.6A	1.3A	0.7A	4A Total	1.6A Total	1.3A Total

Check with factory for availability.

†80% of total output current available on any one output.

*Converters may be operated at the highest transient input voltage, but some component electrical and thermal stresses would be beyond MIL-HDBK-1547A guidelines.



MQBL-28-2R5S

Output: 2.5V

Current: 8A

Ordering Information

PART NUMBERING SYSTEM

The part numbering system for SynQor's MilQor DC-DC converters follows the format shown in the table below.

Not all combinations make valid part numbers, please contact SynQor for availability. See the Product Summary web page for more options.

Example: MQBL-28-2R5S-Y-ES

Model Name	Input Voltage Range	Output Voltage(s)		Package Outline/ Pin Configuration	Screening Grade
		Single Output	Dual Output		
MQBL	28 28E	1R5S	05D 12D 15D	S F	C ES HB
		1R8S			
		2R5S			
		3R3S			
		05S			
		06S			
		7R5S			
		09S			
		12S			
		15S			
28S					

APPLICATION NOTES

A variety of application notes and technical white papers can be downloaded in pdf format from the SynQor website.

Contact SynQor for further information and to order:

Phone: 978-849-0600
Toll Free: 1-888-567-9596
Fax: 978-849-0602
E-mail: mqnbfae@synqor.com
Web: www.synqor.com
Address: 155 Swanson Road
 Boxborough, MA 01719
 USA

PATENTS

SynQor holds numerous U.S. patents, one or more of which apply to most of its power converter products. Any that apply to the product(s) listed in this document are identified by markings on the product(s) or on internal components of the product(s) in accordance with U.S. patent laws. SynQor's patents include the following:

5,999,417 6,222,742 6,545,890 6,594,159 6,731,520 6,894,468
 6,896,526 6,927,987 7,050,309 7,072,190 7,085,146 7,119,524
 7,269,034 7,272,021 7,272,023 7,558,083 7,564,702 7,765,687
 7,787,261 8,023,290 8,149,597 8,493,751 8,644,027 9,143,042

Warranty

SynQor offers a two (2) year limited warranty. Complete warranty information is listed on our website or is available upon request from SynQor.